

TR 4000 / TR 4000 W / TR 4200 Shower Trolleys

Instructions for use - English



Always study this manual carefully before operating the shower trolley.

The operator/user must always have access to the operating manual.

The shower trolley is intended for professional use only where the patient will be under supervision of trained personnel.

Operating instructions and recommended maintenance procedures are explained in the following pages.

If you have any questions regarding the operation or maintenance of your shower trolley and cannot find the answer in this manual, please contact us.

The shower trolley is designed for years of trouble-free operation, with proper use and maintenance.

Max patient Weight: 270 kg / 600 lbs (TR 4200)

Max patient Weight: 450 kg / 1000 lbs (TR 4000 / TR 4000 W)



Always read the user manual

Always make sure that you have the correct version of the manual and it is mandatory to read the Instructions before the first time of using the equipment.



Registered at Medical Products Agency, Sweden as a MDR Class 1 product according to MDR 2017/745. TR reserves the right to make design changes and/or improvements without notice.

Table of Contents

Manufacturer	Page 4
Introduction	Page 5
Intended use	Page 6
Unpacking	Page 7
Safety instructions	Page 8
• General safety instructions	Page 8
• In case of accident	Page 8
Features and controls	Page 9
Product description	Page 10
• General product description TR 4000/-W	Page 10
• General product description TR 4200	Page 10
• Possible combination with other equipment	Page 10
Technical specification	Page 11
• General technical specification	Page 11
• Dimensions TR 4000/-W	Page 12
• Dimensions TR 4200	Page 12
User instructions	Page 13
• Height & Tilt adjustment	Page 13
• Audible tones	Page 13
• Initialisation/Calibration	Page 13
• Charging instructions	Page 14
• Side rails	Page 17
• Corner bumper wheels	Page 17
• Drainage	Page 18
• Castors and Central locking control	Page 18
Patient handling	Page 19
• Patient handling – From sling lift onto the shower trolley	Page 19
• Patient handling – Showering the patient	Page 19

Table of Contents

Product label	Page 20
Table of symbols	Page 21
Routine maintenance	Page 22
• Before every use, Daily maintenance, Monthly maintenance, Annual maintenance	Page 22
• Maintenance every 3 years , 5 years, 10 years - replacement of parts	Page 23
• How to inspect the side rail attachment – not visible screw	Page 24
Cleaning instructions	Page 25
Recycling	Page 27
Maintenance record	Page 28
Training record	Page 29

Manufacturer



TR Equipment AB
Rundelgatan 2
SE-573 35 Tranås
Sweden

Phone: +46 (0)140 77 00 40
www.trequipment.com
info@trequipment.se

Group subsidiaries:

USA

TR Group Inc.

Phone: +1 (800) 7526900
www.trequipment.com
information@trequipment.com

Germany:

TranspoRehamed GmbH

Phone: +49 (0) 212-645850-0
www.transporehamed.de
info@transporehamed.de

Introduction

Dear Customer,

Thank you for choosing one of our quality products. We hope you enjoy the TR 4000/-W & TR 4200 bariatric shower trolley.

This manual shall, in conjunction with staff training, ensure that the operator/user is always using and/or operating the TR 4000/-W & TR 4200 correctly.

New users must be trained by qualified and experienced staff.

TR Equipment AB requires that each user has read and understands the entire operating manual and that they can apply the instructions as specified. This applies to anyone who was not present at the in-service training.

This instruction manual should generally be kept easily accessible for every user. Copying the whole manual is encouraged since its sole purpose is to improve the standard of training and safety.

Please order another copy from us if the instruction manual is lost or unusable, or if it has become illegible over time.

If you need further information, do not hesitate to contact TR Equipment AB or one of our qualified partners.



Always read the user manual

Always make sure that you have the correct version of the manual and it is mandatory to read the Instructions before the first time of using the equipment.

Warning

- Mandatory to read the operating manual before using the equipment.
- Make sure you have read, understand, and applied the information on the following pages before using the shower trolley.

Intended use:

TR 4000/-W & TR 4200 battery operated, bariatric shower trolley

- The TR 4000/-W & TR 4200 bariatric shower trolley is a battery-operated shower trolley.
- The TR 4000/-W & TR 4200 bariatric shower trolley is intended to ease transferring and caring of the patient.

Typical situations where the TR 4000/-W & TR 4200 shower trolley is used includes:

- Transporting the patient to and from a showering area.
- Showering and cleaning the patient.
- Dressing the patient.
- Changing incontinence briefs/pads.

- The TR 4000/-W is NOT intended to be used with a workload that exceed a weight of 450kg (patient + water)
- The TR 4200 is NOT intended to be used with a workload that exceed a weight of 270kg (patient + water).
- The patient is typically a person who is unable to take care of their own personal hygiene.
- The TR 4000/-W & TR 4200 is only intended to be used for short term use <60min when in contact with breached or compromised skin.
- The TR 4000/-W & TR 4200 is intended to be used indoors in all types of care facilities and private homes, including hygiene areas.
- The user is any adult person who is capable of reading and understands the operating manual and is qualified to care for dependent persons/patients.
- Before using the TR 4000/-W & TR 4200 , the user must read and understand the operating manual.

Warning

- Mandatory to read the operating manual before using the equipment
- Make sure you have read, understand, and applied the information on the following pages before using the shower trolley.

Unpacking

TR 4000/-W bariatric shower trolley is delivered on a pallet with a wooden crate around it.

TR 4200 bariatric shower trolley is delivered on a pallet with a cardboard box around it.



TR 4000/-W

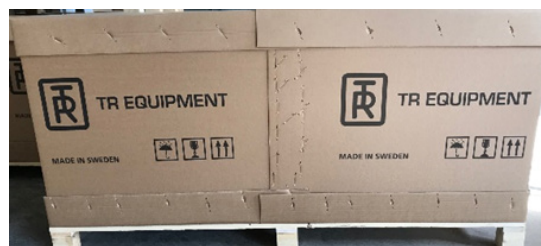

TR 4200

Unpack the TR 4000/-W bariatric shower trolley by carefully cut and remove the plastic that surrounds the wooden crate. **DO NOT** use any sharp tools that may scratch the shower trolley. Remove the crate by unscrewing and remove the screws attached to the wooden pallet. Lift the over the TR 4000/W (2 people required).

Unpack the TR 4200 bariatric shower trolley by removing the lower cardboard staples with a pliers. If the cardboard box is wrapped in plastic, carefully cut, and remove the plastic. **DO NOT** use any sharp tools that may scratch the shower trolley. Lift the cardboard box over the TR 4200 (2 people required).



TR 4000/-W



TR 4200

Unlock the castors and carefully remove the TR 4000/-W & TR 4200 from the pallet.

Warning

When moving the TR 4000/-W & TR 4200 from the pallet, two people are required.

Safety Instructions

- Only qualified staff, who understand all operating and safety procedures may operate the shower trolley.
- Always physically check the water temperature before and during showering.
- The patient must be positioned comfortably on the stretcher mattress, with side rails securely locked.
- The patient's body weight and/or body parts shall never lean or be supported against the stretcher side rails.
- Check that side rails are locked in position and free from damage.
- Make sure that all parts that comes in contact with the patient are intact and without sharp edges.
- Ensure that the shower trolley can be moved, raised, or lowered safely to avoid any pinch injuries on the patient.
- Castor brakes must be securely locked on the shower trolley before transferring a patient and once in position over a drain.
- Operate the shower trolley carefully when transporting patients through narrow corridors or over irregular uneven surfaces.
- Wipe dry under the stretcher to prevent water dripping on the floor.
- The shower trolley must be cleaned after every use. See cleaning instructions in table of contents.
- Ensure that the TR 4000/-W & TR 4200 shower trolley can be moved, raised, or lowered without risking any pinch injuries to the patient.
- Stretcher and mattress must be kept in place, well maintained and all screws must be tightened.
- Avoid skin or eye contact with detergent, which is highly caustic. If contact is made, rinse immediately with excess water. If irritation occurs, consult a doctor. Always read and follow detergent supplier instructions.
- Never clean mattress and pillow in gas sterilization unit. Mattress and pillow will explode.
- It is recommended that the batteries on the TR 4000/-W & TR 4200 bariatric shower trolley are charged daily or whenever the shower trolley is not in use. The batteries cannot be overcharged.
- The TR battery charger is the only approved charger for the TR 4000/-W & TR 4200 bariatric battery operated shower trolley.
- Do not use battery charger in wet or damp areas – Potential shock hazard.
- Make sure that all castors are clean, in place and free from damages.
- Make sure that siderails are in place and free from damage and all screws are tightened.
- Make sure that mattress and pillow must be kept well maintained in place.
- The shower trolley must be inspected visually for sign of wear. The shower trolley should not be used if defects are noted. Prompt service is required.

If you have questions regarding operation or maintenance of your TR 4000/-W & TR 4200 bariatric shower trolley and cannot find the answer in this manual, please contact us!

In case of accident

In case of a serious incident when using the TR 4000/-W & TR 4200 shower trolley, this should be reported to the manufacturer and to the local authorities where you are established.

Warning



- Mandatory to read the Operating manual before using the shower trolley
- Never leave the patient unattended.
- Never sit at the foldable short, head end rail on the stretcher.
- NEVER use the TR 4000/-W & TR 4200 shower trolley in any way that varies from the safety precautions and operating procedures detailed in this manual. The TR 4000/-W & TR 4200 shower trolley must not be operated by anyone until the user has read and understands the instructions in this manual.

Features and Controls

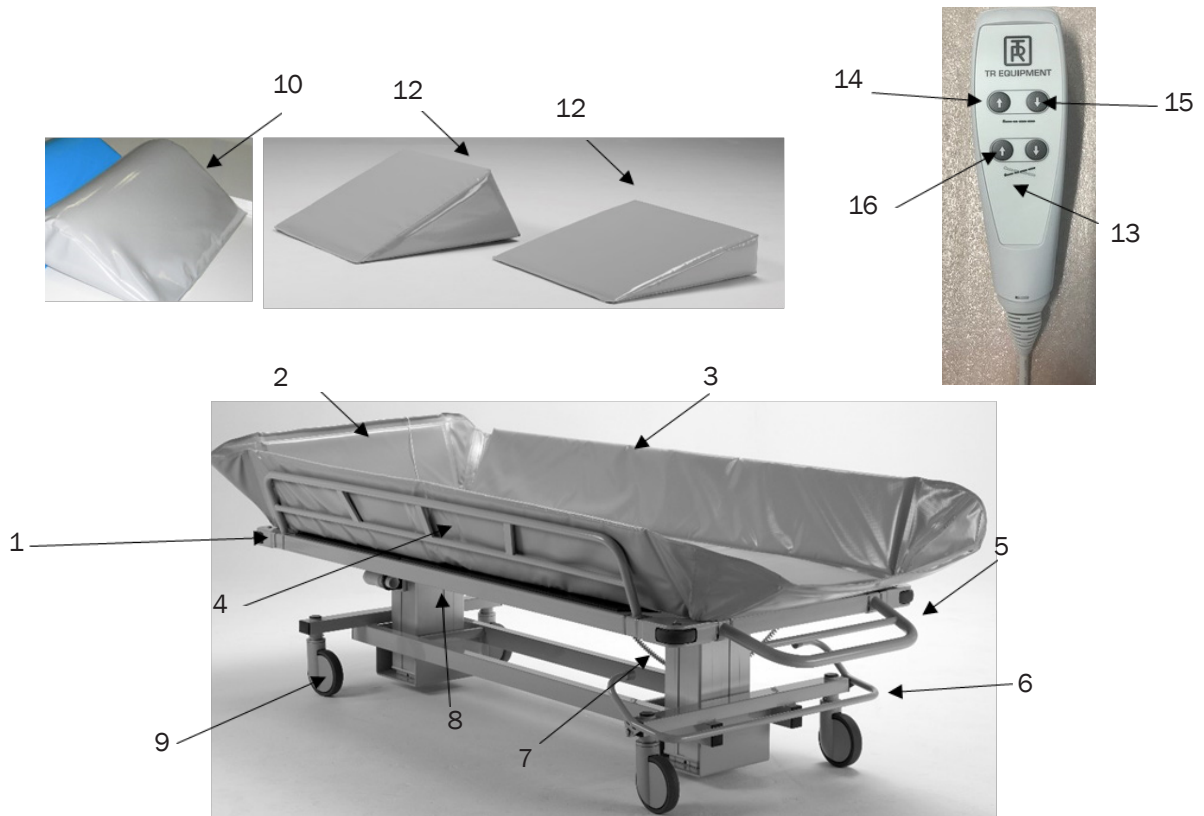

1	Flexible drainage hose
2	Drainage
3	Mattress
4	Foldable side rail
5	Foldable head rail for extra length (TR 4000/-W)
6	Foot control, brakes and straight steering
7	Bumper wheel
8	Lifting columns
9	Straight steering castor

10	Std pillow TR4200
11	Std wedge pillow 15°TR 4000/-W
11	Wedge pillow 15° (option TR 4200)
12	Wedge pillow 30° (option TR 4000/-W)
13	Hand control for height adjustment
14	UP
15	DOWN
16	TILT

Product description

TR 4000/-W – Bariatric shower trolley, battery operated

Height adjustable bariatric shower trolley. As standard equipped with three castors with brake and one straight steering castor, two lifting columns, hand control, battery charger, blue mattress, Blue wedge pillow 15°, drainage, drain plug, drain hose 1M and hose holder.

- Drainage hose 2.5M
- Wedge pillow 30°
- Mattress fastener straps

Contact TR Equipment or you TR Equipment representative for part numbers



TR 4000/-W

TR 4200 – Bariatric shower trolley, battery operated

Height adjustable bariatric shower trolley. As standard equipped with three castors with brake and one straight steering castor, two lifting columns, hand control, battery charger, blue mattress, blue pillow, drainage, drain plug, drain hose 1M and hose holder.

Factory mounted option:

- Spacer kit that raises the height of the shower trolley with 145mm.
- Distance between floor and chassis will not be increased.

Options:

- Mattress fastener straps
- Drainage hose 2,5M
- Wedge pillow 15°
- Wedge pillow 30°

Contact TR Equipment or you TR Equipment representative for part numbers.



TR 4200

Possible equipment combinations	
TR 4000/-W & TR 4200	Shower panel TR 2810



Technical specification

TR 4000/-W & TR 4200 – Bariatric shower trolley	
Control	Hand control for height adjustment
Operating range	535 – 835mm / 21 1/16"– 32 7/8"
Lifting speed	8mm/s
Floor clearance	145mm / 2 61/64"
Mattress and Pillow	Flame retardant PVC material
Protection class	IP X5
Maximum workload TR 4000/-W	450kg / 1000lbs
Maximum workload TR 4200	270kg / 600lbs

TR 4000 – Dimensions and weights	
Length	2210mm / 87"
Patient work area	1980 × 780mm / 77"
Width	915mm / 36"
Weight	140kg / 310lbs

TR 4000-W – Dimensions and weights	
Length	2210 mm / 87"
Patient work area	1980 × 935mm / 77"
Width	1067 mm / 42"
Weight	144Kg / 319lbs

TR 4200 – Dimensions and weights	
Length	2150mm / 84"
Patient work area	1980 × 620mm / 77"
Width	740mm / 29"
Weight	120kg / 265lbs

TR 4000-W & TR 4200 Voltage	
Supply voltage	24 VDC, 7Ah (Lead-acid, rechargeable)
Battery charger input	100-240VAC, 50/60Hz
Battery charger out put	24VDC

Technical life span	10 years if the product is serviced and maintained according to instructions in this manual.
----------------------------	--

Transport and storage	
Ambient temperature	-20°C - +70°C -4°F - +158°F

Technical specification

TR 4000/-W Bariatric shower trolley

Dimensions

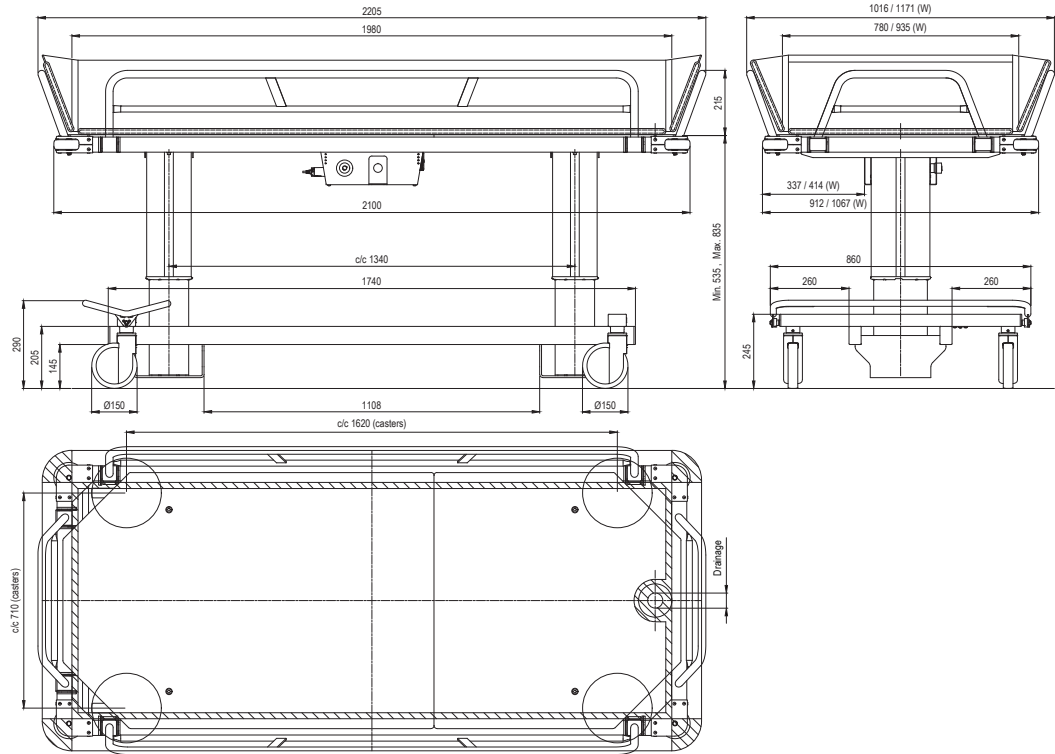

TR 4200 – Bariatric shower trolley

Dimensions

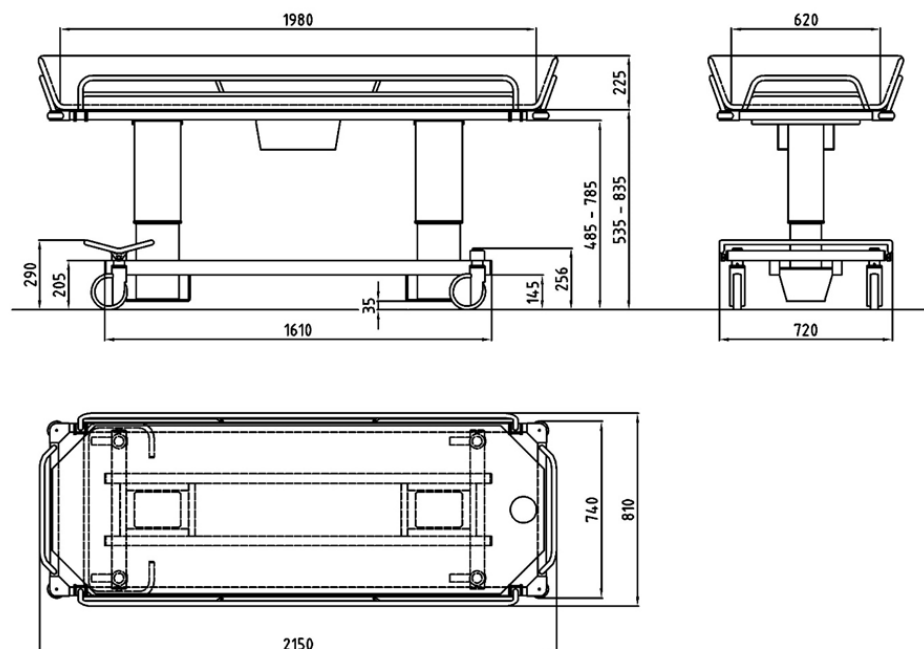

User Instructions

TR 4000/-W & TR 4200 – Height & tilt adjustment

The stretcher is easily and quietly height adjusted and tilted by using the hand control. Two lifting columns are used for the height and tilt adjustment. The lifting columns operates when a button on the hand control is pressed and stops immediately when released.

Raise the shower trolley stretcher by pressing the UP button.
 Lower the shower trolley stretcher by pressing the DOWN button.

When needed the shower trolley stretcher can be tilted maximum 4° in both directions by pressing one of the tilt buttons on the hand control. The stretcher can be tilted for a more comfortable position, to improve the drainage or to a Trendelenburg position.

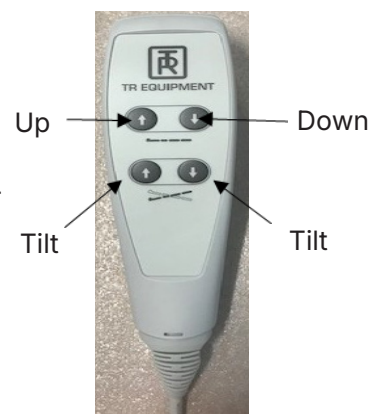

TR 4000/-W & TR 4200 – Audible tone

There are three different audible tones on the TR 4000/-W & TR 4200.

Short tone	This tone indicate that the stretcher is back in level from a tilted position.
Long and short tone:	This tone indicate that the batteries needs to be charged. See table of contents for How to charge the batteries.
Long and two short tones:	This tone indicate that the shower trolley must be initialized/calibrated. See instructions below.

TR 4000/-W & TR 4200 – Initialisation/calibration

- Run the stretcher to its lowest position.
- Press the DOWN button to make sure that the stretcher is in the lowest position.
- Press the DOWN button once more.
- When two short audible tones are heard, the shower trolley is calibrated and ready to use.

Initialisation/calibration must be performed after:

- Power failure, for example, after replacing batteries and/or fuse (15A).
- Replacement of lifting column/columns.



Warning

- If the patient needs "Trendelenburg" position, only qualified staff who understands the procedures may operate the shower trolley.
- TR 4000/-W Maximum workload = 450kg /1000lbs
- TR 4200, Maximum workload = 270kg /600lbs

User Instructions

TR 4000/-W & TR 4200 - Charging instructions:

Charge the TR 4000/-W & TR 4200 shower trolley daily or when the low battery audible tone sounds, when using the hand control. The batteries can't be overcharged. The battery charger is equipped with a magnetic connector to avoid damages on the charger if the shower trolley will be moved during charging.

- Use only the battery charger supplied by TR Equipment.
 - Connect the charger to the charging connector on the shower trolley before connecting the charger to the mains supply.
 - When the battery charger is properly connected the charging indicator on the charger will be lit. If not, make sure the plug on the charger is properly connected.
 - The charging indicator shows the charging cycles. Yellow while charging and Green when the batteries are fully charged.
-
- Minimum charging time is 8 hours. The batteries can't be over charged.
 - When the charging is completed, disconnect the charger from the mains, before you disconnect the charger from the lift.
 - A flat fuse (15A) is connected between the batteries. The batteries are placed under the plastic cover.
 - The charger shall be connected to an outlet which has a Ground Fault Circuit Interrupter.

Charging connector on the shower trolley



Charging connector on battery charger



User Instructions

TR 4000/-W & TR 4200 - Charging instructions removable battery:

Charge the battery daily for at least 8 hours or when the low battery audible tone sounds, when using the hand control. The batteries cannot be overcharged. The battery charger is equipped with a connector with a sealing and a locking function.

- Use only the battery charger supplied by TR Equipment.
- Connect the charger to the charging connector on the removable battery before connecting the charger to the mains supply.
- Charge the battery for at least 8 hours. The battery cannot be overcharged.
- Do not use battery charger in wet or damp areas – Potential shock hazard
- The charger shall be connected to an outlet which has a Ground Fault Circuit Interrupter.
- To start or turn off the battery, push and hold the ON or OFF button for three seconds.

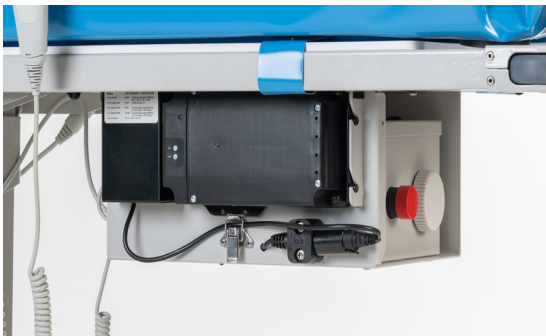

User Instructions

The charging indicator shows following:

- Flashing Green light = Battery is being charged
- Constant Green light = Battery is fully charged even if there is a constant Green light after a short period of time the batteries need to be charged for at least 8 hours.
- When the battery is fully charged (after at least 8 hours) remove the charger from the mains supply before you disconnect the charger from the removable battery.

Charging indicator

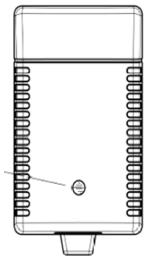

How long does the battery hold the charge.		
Period (Including shipping)	Capacity	Status
3 months	79%	Usable
6 months	58%	Please charge before use
>6 months	<58%	Too long storage period, battery capacity harmed *Be sure to charge 24 hours every 6 months

User Instructions

Side rails

The long side rails are possible to swing down for patient transfer, and lock in upright position for the safety of the patient.

Lower the side rail in horizontal position (A):

Lift the side rail upwards with both hands and lower it into a horizontal position.

Lower the side rail all the way down (B):

Lift the side rail with both your hands from the horizontal position and lower it all the way.

Raise the side rail:

Raise the side rail with both hands by simply lifting it back into its upright position. Make sure that its locked into position before using the shower trolley.

The stretcher width can be narrowed by holding the side rails in a vertical position when transporting the shower trolley through narrow doorways.

Head end rail (TR 4000/-W only).

The head end rail lowers into a horizontal position for extra person length and more access when transferring.

Lower the end rail (C):

Lift the end rail with both hands and lower it into a horizontal position.

Raise the end rail:

Raise the head end rail with both your hands by simply lifting it into its upright position. Make sure that its locked into position before using the shower trolley.



Corner bumper wheels

The TR 4000/-W & TR 4200 shower trolley is equipped with corner bumper wheels in all four stretcher corners to protect walls and doorways.



User Instructions

Drain hose and plug

Drain hose:

The flexible drain hose is connected to the drain outlet on the mattress.

To reduce water dripping on the floor, after use, fold the drain hose upwards by using the hose holder.

Drain plug:

The drain plug is fastened with a nylon string on the stretcher foot end rail.



Black / Straight steering

Green / Neutral

Red / Brake

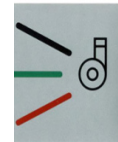

Central locking control bar

Castors with brake:

Lock all four castors on the shower trolley by pressing the central locking control bar all the way DOWN until it clicks into Red position (D).

Unlock the castors by lifting the central locking control bar into the **Green** neutral position or press the short ends of the control bar downwards (E).

Straight steering castors:

One of the foot end castors can be locked into a straight steering position. Lock the castor in straight steering position by lifting the central locking bar until it clicks into **Black** position or press the short ends of the control bar downwards (F).

Unlock the straight steering castor pressing the central locking control bar to a neutral position (E).



Brake position



Neutral position



Straight steering position

User Instructions

Patient handling – From sling lift onto shower trolley

- Lower the TR 4000/-W & TR 4200 to its lowest position by pressing the Down arrow button on the hand control.
- Position and lock the castor brakes by pressing the central locking control bar downwards until it clicks into position.
- Make sure that both bed guard rails are in raised position and securely locked.
- Lower the patient into the shower trolley. When lowering the patient, make sure that no body parts can be pinched and that the patient is placed in a comfortable position.
- Adjust the TR 4000/-W & TR 4200 to an ergonomic and comfortable height.
- After removing the sling from the patient unlock the castor brakes and transfer the patient to the showering area.

Patient handling - Showering the patient

- When showering, the patient must remain on the shower trolley stretcher with the side rails in an upright position and securely locked.
- If possible, place the foot end of the shower trolley over the floor drainage, sink or toilet. Activate the brake on the castors by pressing the central locking control bar downwards until it clicks into position (D).
- Make sure drainage hose is attached to the drainage and attach the drain plug on the mattress drainage.
- Tilt the stretcher, using the hand control, to a comfortable position and to ease the drainage. If desired, remove the drain plug.
- Shower the patient. Body fluids and faeces must be removed immediately to prevent stains on the mattress.
- After showering the patient, keep him/her warm, wrapped in a bath towel.
- Thoroughly drain the stretcher. Wipe dry with a towel.
- To prevent water dripping on the floor during transport, attach the drain plug, fold the drainage hose upwards using the hose holder.
- To level the stretcher, use the hand control. An audible tone will be heard when the stretcher is in level.

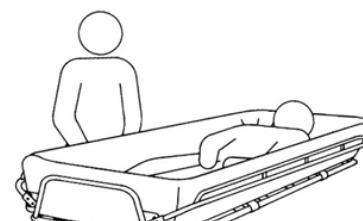

Brake position

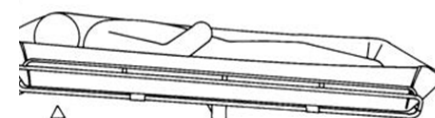

Clean and wipe the shower trolley dry after every use.

Warning

- Never leave patient unattended at any time.
- Always check the water temperature physically, by hand before showering the patient. Scalding risk!
- Always use the hose holder to prevent dripping on the floor during transport.
- If the patient needs "Trendelenburg" position, only qualified staff who understand the procedures may operate the shower trolley.

Product label

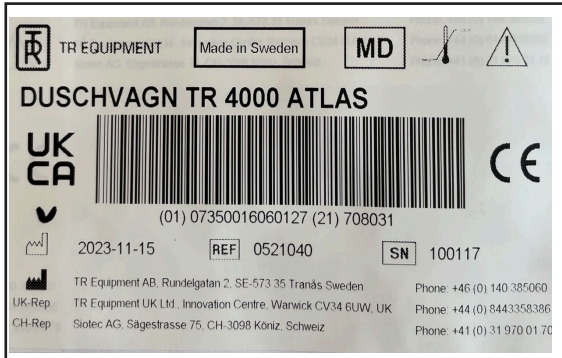

UDI (Unique Device Identification) can be found within the barcode human readable text. It contains:

- (01) EAN code
- Date of Manufacture. The date is in the format YYYYMMDD Y = Year, M = Month and D = Date.
- Serial Number displayed as six digit code.

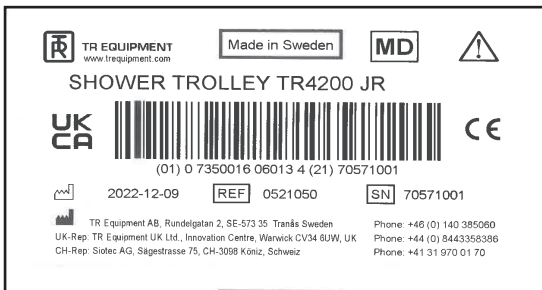













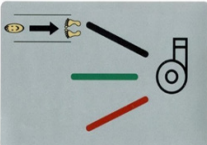
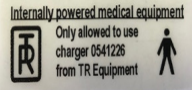

Table of Symbols

 TR EQUIPMENT	TR Equipment Logotype		Visual inspection
	Medical equipment according to MDR 2017/745		Read the manual
	CE marking		Patient weight shall not exceed 270kg (TR4200) Patient weight shall not exceed 450kg (TR 4000/-W)
	Manufacturing date		WEEE Symbol May not be discarded in domestic waste
	Factory address		UK
	Part number		Refer to Instruction manual (IFU)
	Serial number		Symbol on battery charger: Class II, double insulated
	Instruction for foot control: Black = Straight steering, Green = Neutral, Red = Brake activated. Moving direction illustration. The attendant driving the shower trolley must always be placed at the head end side.		Internally powered medical equipment Use only battery charger supplied by TR Equipment Applied Part B

Routine maintenance

The recommended frequency of these maintenance procedures will depend on how often the equipment is used. It's good practice to establish these procedures and then adjust the frequency as your conditions indicate.

Before every use

Visual inspect the TR 4000/-W & TR 4200 bariatric shower trolley:

- Make sure that it stands securely on the floor.
- Make sure that it is possible to raise, lower and tilt the shower trolley stretcher.
- Make sure that the hand control is free from damage and functioning.
- Make sure that there are no damages on the stretcher, mattress and pillow that might hurt the patient.
- Make sure the Black protective caps are mounted on the chassis. If not, add new ones.

Daily maintenance:

- Clean the shower trolley according to the cleaning instructions. See table of contents, "Cleaning instructions".
- Charge the batteries daily or whenever the shower trolley is not in use. The batteries can't be overcharged. See table of contents, "Charging instructions".

Monthly maintenance:

- Make sure that all screw and fastenings are tightened properly.
- It's important that all screws and fastenings are checked and tightened if needed – including those not easily visible. See table of contents, "How to inspect the side rail attachment – not visible screws".
- Check components for signs of damage or high level of wear.
- Check that both lifting columns for signs of wear. Raise and lower the stretcher to easier identify damages and wear.
- Inspect side rails to ensure they are in good condition, and that all fasteners are in place and functioning properly.
- Inspect the castors to ensure they are clean and that the brake function and straight steering function is fully functioning.
- Check that the raising and lowering function to ensure smooth operation throughout the entire lift range.
- Initialise the lifting columns. See table of contents, "Initializing/Calibrating the lifting columns".

Annual maintenance:

- Repeat Before every use, Daily maintenance and Monthly maintenance.
- Thorough inspection of all steps mentioned above. We recommend that the annual maintenance is performed by approved and designated staff. Use the check list in our Service and maintenance manual.

If you don't have the Service and maintenance manual, contact TR Equipment or your TR Equipment representative to get a new one. See contact info on www.trequipment.com.



Warning

- Maintenance and/or repairs may only be carried out by the manufacturer or qualified staff authorised by the manufacturer, otherwise warranty expires immediately.

Important

- Shower trolleys should immediately be taken out of operation if defects or irregularities are noted. Prompt service is required.

Routine maintenance

Maintenance Every 3 years

- Repeat Before every use, Daily, Monthly and Annual maintenance.

Replace following parts on the TR 4000/-W & TR 4200:

- Replace batteries
 - Integrated batteries (2 units) Part.no: 819030
 - Removable battery Part no: 200110
- Replace the drainage Part.no: 829392
- Replace drainage plugs Part no: 829391
- Replace drainage hose Part.no: 820818-4224 (1M) / 820818-4224-25 (2,5M)

Maintenance Every 5 years

- Repeat Before every use, Daily-, Monthly- and Annual maintenance.
- Inspect the quality of the mattress and pillow.
- Inspect the quality of the lifting columns.
- Inspect the quality of the battery charger.
- Inspect the quality of the central locking control bar.

Replace following parts:

- Replace castors
 - Castors with brake (3pcs) Part.no: 850132
 - Straight steering castor (1pcs) Part.no: 850131



Warning

- Maintenance and/or repairs may only be carried out by the manufacturer or qualified staff authorised by the manufacturer, otherwise warranty expires immediately.

Routine maintenance

Maintenance after 10 years

Repeat Before every use, Daily maintenance, Monthly maintenance, Annual maintenance, Maintenance every 3 years, and Maintenance every 5 years.

How to inspect the side rail attachment – not visible screws.

- Remove the pillow, mattress, drainage and activate the castor brakes by pressing the central locking control bar downwards until it clicks into position.
- Remove the screw for the corner bumper wheel.
- When a corner bumper wheel is removed you see the side rail screws attached to the stretcher frame.
- All screws must have driloc/thread selant.
- **Check that the screws are fastened properly!**
- Attach the corner bumper wheel again.
- Put pillow, mattress and drainage back on again



Warning

- Maintenance and/or repairs may only be carried out by the manufacturer or qualified staff authorised by the manufacturer, otherwise warranty expires immediately.

Cleaning instructions

General guidelines for cleaning detergent

- Nonabrasive type of detergent
- Less than 5 Wt% chloride content
- Less than 3 Wt% alcohol content

TR 4000 / 4200 Shower trolley

The User/operator is responsible for selecting the detergents and additives. Please read the detergent supplier's instruction manual and find out whether the product is suitable or not.

The shower trolley must be cleaned immediately after use. Dry the unit well before fastening the mattress.

Do not use solvent based cleaning liquids, which can damage or stain the mattress and pillow surface.

The shower trolley has a removable mattress and pillow made of PVC fabric. For a thorough cleaning of the shower trolley the mattress and pillow must be removed.

- Loosen the mattress straps (4pcs).
- Remove the plastic plate/plates.
- After cleaning the mattress and pillow thoroughly rinse them with the patient shower. Wipe and dry before using the shower trolley again.

Use a sponge or brush, and promptly remove any soap or lime deposits, and faeces to avoid spots/stains. **Always** rinse thoroughly with fresh water after using cleaning detergents.

Regular cleaning prolongs the lifetime of the product.

Mattress, re-attachment:

The mattress is attached to the stretcher with the fastening straps (4pcs). Press the strap button onto the button on the inside of the stretcher frame.



Cleaning instructions

TR 4000 / 4200 Shower trolley

- Select cleaning interval according to the degree of contamination.
- Contaminations should be removed as soon as possible in order to prevent material damage.
- Do not clean material with tools which might damage surfaces. Use a towel, sponge or a soft brush.
- Store mattress and pillow in a clean and dry condition only.
- Use natural, slightly alkaline detergent containing no solvents.
- Do not use products such as trichlorethylene that will damage the PVC surface on mattress and pillow.
- Do not use iodine based, disinfectants, this can discolor the PVC fabric on mattress and pillow.
- Do not use water hotter than 45°C / 113°F
- Avoid excessive friction and abrasive detergents when cleaning as this may damage the surfaces of the shower trolley.

Cleaning process for mattress, pillow and plastic plate:

- Lightly brush off loose dirt particles first, then rinse material with clear water.
- Spray on the cleaning product in indicated concentration or apply with a clean towel. Dose the amount according to degree of contamination.
- Allow the cleaning product to act for 2-5 minutes and wipe off with a towel.
- Rinse off dirt and cleaning product residues thoroughly with cold or lukewarm water to prevent material discolorations. Store mattress and pillow only if it's clean and completely dry.

Disposal / Recycling

Recycling of the equipment

- Pillow and mattress are produced in lacquered PVC fabrics and filling materials are in Polyethen/Polyether.
- Pillow and shall be recycled as flammable materials.
- Plastic plate shall be recycled as flammable material.
- Metal parts shall be recycled in Metal recycling
- Castors are produced in Polyurethane and shall be recycled as flammable materials.
- Bolts shall be recycled as metal parts



Important:

- When replacing batteries, deposit the batteries in accordance with national regulations.
- When replacing electrical and electronical parts/components, deposit the parts/components in accordance with national regulations.



Recycling of packaging materials.

- Wrapping materials is cardboard box and a wooden pallet.
- Cardboard box, cardboard bottom and cardboard lid shall be recycled as cardboard and pallet shall be recycled as wooden materials.

Warning

- Never use solvent based or strong alkaline cleaning liquids, which can damage or stain the mattress and pillow surfaces.
- Never clean the mattress and/or pillow in gas sterilization unit. Mattress and pillow will explode.
- Wipe the stretcher dry to prevent water dripping on the floor.
- Do not let the shower trolley dry in sunlight or close to a heater. This will cause discoloration. Avoid damage from overheating.

Important

- The user/operator is responsible selecting the correct cleaning liquid/detergent and additives according to local regulations and safety standards. Please read the cleaning liquid/detergent supplier's instruction manual and find out whether the product is suitable for use with this product.

Thank you for reading this document.

If you have questions regarding operation or maintenance of your equipment and cannot find the answer in this manual, please do not hesitate to contact us!